

Table of Contents

1. Introduction.....	1
2. Safety note	1
3. Explanation of controls and indicators	3
3-1. Meter illustration	3
3-2. Functional push button	4
3-3. Display indicators	5
4. Specification	6
4-1. General Specification.....	6
4-2. Electrical Specification (at $23\pm 5^{\circ}\text{C}$; <75% RH).....	7
5. Measurement operation	10
5-1 DC & AC voltage measurement	10
5-2. Resistance measurement	10
5-3. Diode/Continuity check.....	11
5-4. Frequency Measurement	12
5-5. DC/AC μA or mA measurement.....	13

5-6. DC/AC 10A measurement	13
6. Maintenance.....	14
6-1. Replacing the battery	14
6-2. Fuse replacement.....	14
6-3. Cleaning and Decontamination	14

1. Introduction

This Meter is a handheld and battery operated Digital Multi Meter(DMM) with multi function. This Meter is designed to meet IEC61010-1 & CAT III 600V over voltage category and double insulation. The meter with holster that is giving the main body, though downsized, high resistance against the shock of a drop. CAT III: Measurements on Mains distribution parts of the buildings. Typical short-circuit current < 50 kA.

This operating instruction covers information on safety and caution. Please read relevant information carefully and observe all the warnings and note strictly.

The DMM as general measurement tool and widely used in the school, laboratory, factory and other social field.

2. Safety note

 Warning











To avoid possible electric shock or personal injury and to avoid possible damage to the meter or to the equipment under test, adhere to the following rule:

- ⇒ Do not apply more than the rated voltage, of marked on the meter, between the input terminal and grounding terminal..
- ⇒ Do not apply voltage between COM and OHM terminal, in the resistance measuring state.
- ⇒ Do not measure current with test lead inserted into voltage or OHM terminal.
- ⇒ Do not expose the instrument to the direct sun light, extreme temperature and humidity or dew full.
- ⇒ Inspect the test lead for damaged insulation or exposed metal.

- ⇒ Before measuring current, check the Meter's fuses and turn off power to the circuit before connecting the meter to the circuit.
- ⇒ Disconnect circuit power and discharge all high voltage capacitors before testing continuity, diode, resistance, capacitance or current.

Note international Electrical Symbol.

	Dangerous Voltage		Ground
	AC Alternating current		Warning see explain in manual
	DC (Direct Current)		Double insulation
	AC or DC		Fuse

Measurement category(over voltage category):

This instrument is meet the safety condition of CAT III. The equipment is used for measurement in building facilities. Examples are measurements on distribution boards, circuit breaker and industrial equipment located in fixed facilities, as a fixed motor.

3. Explanation of controls and indicators

3-1. Meter illustration

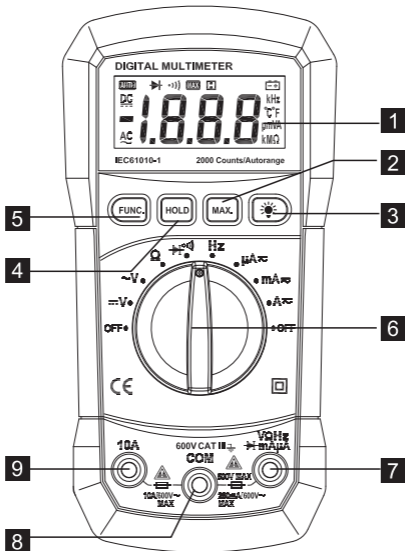



Fig. 1 Exterior view

- 1** LCD display **2** "MAX" push button
3 "BACK LIGHT" push button **4** "HOLD" push button
5 "FUNC." Push button **6** Rotary Switch (Knob)
7 "V/Ω/HZ/uA/mA" Input terminal
8 "COM" input terminal **9** "10A" input terminal

3-2. Functional push button

Push button	Function
Func	"FUNC" key is the function select key that acts with trigger. Use the key as switch of DC/AC current, Diode/Continuity and Hz .
HOLD	Press "HOLD" to enter and exit the hold mode in any mode. That act with trigger.
MAX	This key is act with trigger. Press this key once, the maximum value is holding (Will displays 'MAX' symbol in the LCD). After pressing the key, A/D will keep working, and the display value are always up dated and kept the maximum value. NOTE: The actual gained value is not the peak value.
	This key is used control Backlight. This key is act with trigger. When press and hold the key over 2 sec, will enable Backlight. Press the key again , the backlight will disable.

3-3. Display indicators



Fig. 2 LCD

Indicator	Meaning
	DC voltage or current
	AC voltage or current
	Diode
MAX	Maximum value
HOLD	Data hold
	Low battery indicator
MKΩ	Ω KΩ MΩ is unit of resistance
μmVA	mV ,V is unit of voltage μA, mA, A is unit of current
-	Indicate negative reading

4 . Specification

4-1. General Specification

- Auto ranging DMM , that full scale is 2000 counts
- Display : 3 1/2 digit LCD display..
- Over load protection: Used the PTC protection circuit for Resistance, frequency measurement.
- DATA HOLD function
- MAX value hold function
- Back Light
- Low battery indication
- Auto Power- OFF. : If the meter is idle for 15 minutes (idle time), the meter automatically turns the power off. After auto power-off, pushing any of the push button or changing the rotary switch can turn on the meter again.

NOTE



After auto power off in the AC mode, if changing the rotary switch to the DC mode, the Re-power on if disabled. The meter enters sleep mode after quto power off. If press "HOLD" push button to re-power on in the sleep mode, the auto power off function is disabled.

- Operating temperature & Humidity:
0 ~ 40°C (32 ~104 °F) & < 80% RH
- Storage temperature & Humidity:
-10 ~ 50°C (14 ~ 122 °F) & < 70%RH
- Power Supply: 9V Battery(6F22 or 1604A Type) x 1pc.
- Safety Class: IEC 61010-1, CAT III 600V.
- Dimension(L x W x H) & Weight:140 x 67 x 30mm, Approx.112g

4.1.1 Accessory:

- | | | |
|---|----------------------|------|
| ① | User' s Manual ----- | 1pc |
| ② | Test lead ----- | 1set |
| ③ | 9V Battery ----- | 1pc |

4-2. Electrical Specification (at 23±5°C; <75% RH)

4.2.1 DC Voltage

Range	Resolution	Accuracy
200mV	0.1mV	± (0.5% rdg + 2dgt)
2V	0.001V	
20V	0.01V	
200V	0.1V	
600V	1V	± (0.8% rdg + 2dgt)

* Over load protection: Maximum 600V DC or AC RMS

4.2.2 AC Voltage

Range	Resolution	Accuracy
2V (40Hz-400Hz)	0.001V	± (0.9% rdg + 3dgt)
20V (40Hz-400Hz)	0.01V	
200V (40Hz-400Hz)	0.1V	
600V (40Hz-200Hz)	1V	± (1.2%) rdg + 3dgt

* Over load protection: Maximum 600V DC or AC RMS

4.2.3 Resistance

Range	Resolution	Accuracy
200Ω	0.1Ω	± (0.8% rdg + 2dgt)
2kΩ	0.001kΩ	
20kΩ	0.01kΩ	
200kΩ	0.1kΩ	
2MΩ	0.001MΩ	± (1.0% rdg + 2dgt)
20MΩ	0.01MΩ	

4.2.4 Diode check

Range	Resolution	Function
▶	0.001V	Will display the forward drop voltage

* Operating current : about 1mA

* Open circuit voltage : about 1.48V

4.2.5 Continuity

Range	Function
•)	If measured resistance less than 100Ω, will buzzer is sounded.

* Open voltage: about 0.5V

4.2.6 DC Current

Range	Resolution	Accuracy
200μA	0.1μA	± (1.5% rdg + 3dgt)
2000μA	1μA	
20mA	0.01mA	
200mA	0.1mA	
10A	0.01A	± (2.0% rdg + 5 dgt)

* Over Load protection : use the fuse(F250mA/600V) at μA/mA range, and use the fuse(F10A/600V) at 10A range.

* Max input current: : 250mA at 'mA' input terminal and 10A at '10A' input terminal.. .

4.2.7 AC Current [40Hz-400Hz]

Range	Resolution	Accuracy
200 μ A	0.1 μ A	$\pm (1.5\% \text{ rdg} + 5\text{dgt})$
2000 μ A	1 μ A	
20mA	0.01mA	
200mA	0.1mA	
10A	0.01A	$\pm (2.5\% \text{ rdg} + 5\text{dgt})$

- * Over Load protection : use the fuse(F250mA/600V) at μ A /mA range,and use the fuse(F10A/600V) at 10A range.
- * Max input current: : 250mA at 'mA' input terminal and 10A at '10A' input terminal...
- * Frequency response : 40 ~ 400Hz

4.2.8 Frequency

Range	Resolution	Accuracy
20kHz	10KHz	$\pm (1.5\% \text{rdg} + 5\text{dgt})$

- * Sensitivity : 0.8V

5. Measurement operation

5-1 DC & AC voltage measurement



To avoid harms to you or damage to the meter from electric shock. Please do not attempt to measure voltage higher than DC/AC 1000V although readings may be obtained.

The DC voltage range are 200.0mV, 2.000V, 20.00V , 200.0V and 600V and then. The AC voltage ranges are 2.000V, 20.00V, 200.0V and 600V.

To measure DC or AC voltage:

- ① Insert the red test lead into the "**VΩ**" input terminal and the black test lead into the COM terminal.
- ② Set the rotary switch to **DC or AC** range.
- ③ Connect the test lead across with the object under testing. The measured value will be show on the LCD display.



When DC or AC voltage measurement has been completed, disconnect the connection between the testing lead and the circuit under testing.

5-2. Resistance measurement

The resistance range are: 200.0Ω, 2.000KΩ, 20.00KΩ, 200.0KΩ , 2.000MΩ. 20.00MΩ.

To measure resistance, connect the meter as follows:

- ① Insert the red test lead into the "**VΩ**" terminal and the black test lead into the COM terminal.
- ② Set the rotary switch to proper resistance range.
- ③ Connect the test lead across with the object under testing.

The measured value will be show on the LCD display.

NOTE

- ◆ The test lead can add 0.1Ω to 0.2Ω of error to resistance measurement. To obtain precision reading in low-resistance measurement, that is the range of 200.0Ω , short the input terminal before measuring. In this time, the contact resistance displayed on the LCD. You can subtract the contact resistance value from the measured value.
- ◆ For high-resistance measurement ($>10M\Omega$), it is normal taking several second to obtain stable reading.
- ◆ The LCD display "OL" indicating open-circuit for the tested resistor or the resistor value is higher than the maximum range of the meter.

5-3. Diode/Continuity check

5.3.1. Diode

- ① Set the rotary switch to "→ 000" position. First time, default mode is diode check mode. You can enter the continuity check mode by the "FUNC" Key.
- ② insert the red test lead into the "**VΩ**" terminal and the black test lead into the "COM" terminal.
- ③ Use the diode test mode to check diodes, transistors and other semiconductor device. In the diode test mode sends a current through the semiconductor junction, and the measure the voltage drop across the junction. A good silicon junction drop between $0.5V$ and $0.8V$.
- ④ For forward voltage drop reading on any semiconductor component, place the red test lead on the component anode and place the black test lead on the component cathode. The measured value show on the display.

- ⑤ Reverse the test lead and measure the voltage across the diode again.
- If diode is good, the display shows "OL" .
 - If diode is shorted, the display shows 0 in both direction.
 - If display shows "OL" in both direction, the diode is open.

5.3.2. Continuity Check:

- ① Press the "FUNC" key to enter to the continuity mode.
- ② The buzzer sound if the resistance of a circuit under test is less than 100Ω .

5-4. Frequency measurement

- ① Set the rotary switch to "Hz" position.
- ② Insert the red test lead into the "V Ω Hz" input terminal and the black test lead into the "COM" terminal.
- ③ Connect the test leads across with the circuit under testing. The measured value shown on the LCD display.

NOTE: Input signal level must be higher than 0.5V (it is sensitivity).

5-5. DC/AC μ A or mA measurement

DC Current range is 200.0 μ A/2000 μ A and 20.00mA,/200.0mA and then 10A range.

AC Current range is 200.0 μ A/2000 μ A and 20.00mA,/200.0mA and then 10A range.

- ① Turn off power to the circuit. Set the rotary switch to the proper DC/AC μ A or DC/AC mA position.
- ② Break the current path to be tested. Connect the red test lead to the more positive side of the break and the black test lead to the more negative side of the break.
- ③ Turn on power to the circuit. The measured value show on the display.

5-6. DC/AC 10A measurement

- ① Insert the red test lead into the input terminal marked as "10A" .
- ② The measuring procedure is same as that of 5-5 section.

NOTE

- For safety' s sake, the measuring time for high current should be ≤ 10 second for each measurement and the interval time between two measurement should be greater than 5 minutes.
- When current measurement has been completed, disconnect the connection between the testing lead and the circuit under test.

6. Maintenance

6-1. Replacing the battery

When meter display  the battery must be replaced to maintain normal operation.

- ① Disconnect and remove all test probes from any live source and meter.
- ② Open the battery cover on the bottom case by screwdriver.
- ③ Remove old battery and snap new one into battery holder

6-2. Fuse replacement

Replacing the defective fuse should be done according to the following procedure.

- ① To avoid electrical shock, remove the test lead and any input signal before opening the bottom case.
- ② Open the bottom case and then remove the defective fuse and insert a new fuse of the same size and rating.
- ③ Replace the bottom case and reinstall all the screws.

6-3. Cleaning and Decontamination

The meter can be cleaned with soft clean cloth to remove any oil, grease or grime. Do not use liquid solvent or detergent.